

GENERAL CHARACTERISTICS

The pressure sensor measures pressures in liquids and gases. The strong all-metal construction enables the device to be universally employed throughout industry. With flush membrane this sensor is suitable for applications with sticky fluids like glue components or other critical liquids. The pressure sensor consists of a measurement probe (four strain gauges in thin-film poly silicon technology accommodated on a monolithic silicon substrate, oil filled cavity with flush diaphragm) and the evaluation electronics which converts the bridge signal into a 4..20 mA signal proportional to the pressure. The sensor requires less than 2 mA for a supply so that a two-wire connection can be realised. This type of connection enables monitoring of cable defects.

- * 4..20 mA, two-wire connection
- * all stainless steel diaphragm
- * rotating plug connection (infinitely variable)

male thread G1/2A stainless steel



TECHNICAL DATA

measurement ranges	range	overload
relative pressure	0 - 1	4
overload limit (bar)	0 - 2,5	10
	0 - 6	24
	0 - 10	40
	0 - 25	100
	0 - 60	240
	0 - 100	400
	0 - 250	600
	0 - 400	600
options	additional measurement ranges absolute pressure metering (low limit 10mbar abs.)	
accuracy	1% / of 60°C 0,02% /°C	
reproducibility	0.5%	
operating temp. for electronics	0..80°C	
operating temperature	max. 80°C (with option goose-neck option 125°C max.)	
weight	0.3kg	

MOUNTING

The sensors are screwed into a sleeve or a T-piece in the pipework using a suitable sealing material (Teflon tape, Sikurite seal, etc.). The mounting of the sensor should not cause any significant change of cross-section in the pipe system. When tightening the sensor, be sure to only use the proper hexagonal wrench (27mm AF). Avoid points of installation subject to high pressure shocks (see overload limit).

After sealing the sensor can be turned into the correct position for the cable connection. A mechanical block limits the total range turnable of 360°.

MATERIALS

pressure transducer stainless steel 1.4301
other materials brass nickel plated, PP, NBR

with connection at locking plugs M12x1, 4pole

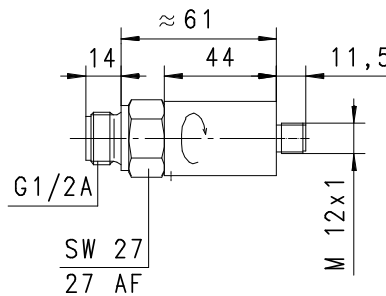

with plug DIN 43650-A

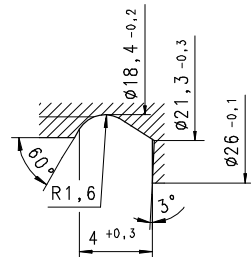
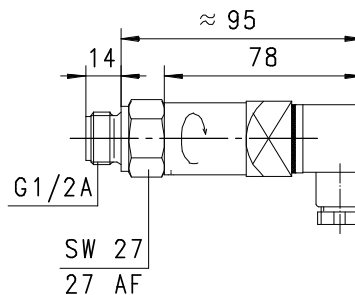

recess
DIN 3852 Bl.2

"goose-neck" option for higher temperatures

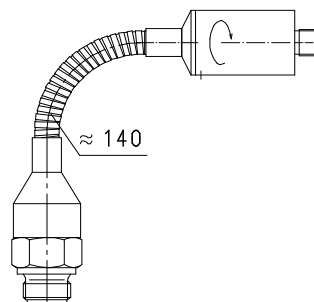

ELECTRICAL DATA

supply voltage	10..30 V DC ±10%
analogue output	4..20 mA
max. load	700Ω at 24 V (100Ω at 10V - 1K at 30V, linear to the operation voltage)
connection	for locking plug M12x1, 4pole or plug DIN 43650-A
protection class	IP 67 locking plug IP 65 plug DIN 43650-A

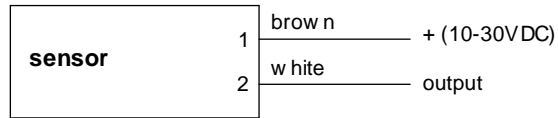

Before carrying out the electrical installation, make sure that the supply voltage corresponds to the data specification!

It is recommended to use shielded cable < 30 m, supply lines < 10 m

MOUNTING POSITION

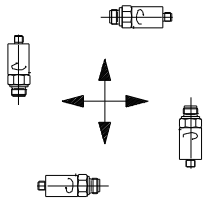

METERING SUBSTANCES

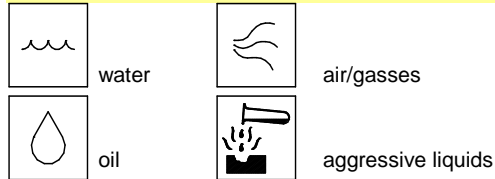

NOMENCLATURE

EPS-	006	R	K	015	S		basic type specification
	006					●	0 - 6 bar
	025					●	0 - 25 bar
	060					●	0 - 60 bar
	100					●	0 - 100 bar
	250					●	0 - 250 bar
	400					●	0 - 400 bar
		R				●	relative pressure
		A				○	absolute pressure
			K			●	material medium contact stainless steel 1.4301
				015		●	connection G1/2A
					S	●	connection at locking plugs M12x1, 4-pole
					B	●	plug DIN 43650-A
					H	○	with goose-neck

ACCESSORY

locking plug

K	PU-	02	S	G	basic type specification
K					● ready-made cable
KB04					● self makable cable 4-pole
	PU-				● material PUR
		02			● length 2 m
		05			● length 5 m
		10			● length 10 m
			S		● moulded-on plug
				G	● straight plug
				W	● angled plug 90°



COMBINATIONS

omni-P

local electronic unit,
2xNPN and PNP switch
4(0)...20mA output
graphical LCD display
with flashing LED
program ring



Flex-P

switch- or frequency output
0..10V or 4..20mA
PNP, NPN

All technical changes reserved

●BASIC Standard ○BASIC Programme option □VARIO Special option ⊕ PLUS Accessories ✗ not recommendable