

GENERAL CHARACTERISTICS

Mechanical Flowmeter for liquids. A bellow-supported paddle activates a metering unit with a pointer range of 270°. Rugged design in brass or stainless steel.

- * local metering
- * low pressure loss
- * good repeatability
- * dirt-resistant
- * easy adjustment by indicating pointer



Female thread G1/2 to G2 brass/stainless steel



UZ-025GM100

TECHNICAL DATA

	G	Type	Qmax. recom. l/min H ₂ O	metering range l/min H ₂ O ; 1bar abs				H mm	L mm	AF mm	X mm	weight kg
				flow from								
				left		right (optional)						
brass	G 1/2	UZ-015GM...	60	3 - 50		2 - 35		201	70	30	16	2.0
	G 3/4	UZ-020GM...	100	4 - 60		4 - 45	6 - 70	206	74	36	18	2.0
	G 1	UZ-025GM...	200	4 - 60	10 - 100	4 - 50	10 - 100	201	87	46	19	2.5
	G 1 1/4	UZ-032GM...	300	10 - 100	20 - 200	10 - 100	20 - 200	209	104	55	22	3.0
	G 1 1/2	UZ-040GM...	400	20 - 200	10 - 300	20 - 200	10 - 300	215	111	65	24	4.5
G 2	UZ-050GM...	600	20 - 300	30 - 500	60 - 300	100 - 500	227	130	70	28	5.0	
stainless steel	G 1/2	UZ-015GK...	60	3 - 50		2 - 35		201	70	30	16	2.0
	G 3/4	UZ-020GK...	100	4 - 60		4 - 45	6 - 70	206	74	36	18	2.0
	G 1	UZ-025GK...	200	4 - 60	10 - 100	4 - 50	10 - 100	201	87	46	19	2.5
	G 1 1/4	UZ-032GK...	300	10 - 100	20 - 200	10 - 100	20 - 200	209	104	55	22	3.0
	G 1 1/2	UZ-040GK...	400	20 - 200	10 - 300	20 - 200	10 - 300	215	111	65	24	4.5
	G 2	UZ-050GK...	600	20 - 300	30 - 500	60 - 300	100 - 500	227	130	70	28	5.0

Metering range is indicated for horizontally increasing flow.
Please notice the pressure-dependent deviation of the indication range.

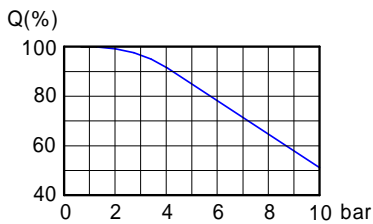

- tolerance ±3% of full scale
- pressure range 16 bar static
6 bar dynamic
- media temperature max. 100°C
- average pressure loss 0.2 bar at Qmax.

MATERIALS

	UZ-...GM	UZ-...GK
housing	brass Ms58 nickel plated	stainless steel 1.4305
paddle	stainless steel 1.4571 ; 1.4305	stainless steel 1.4571 ; 1.4305
bellow	stainless steel 1.4571	stainless steel 1.4571

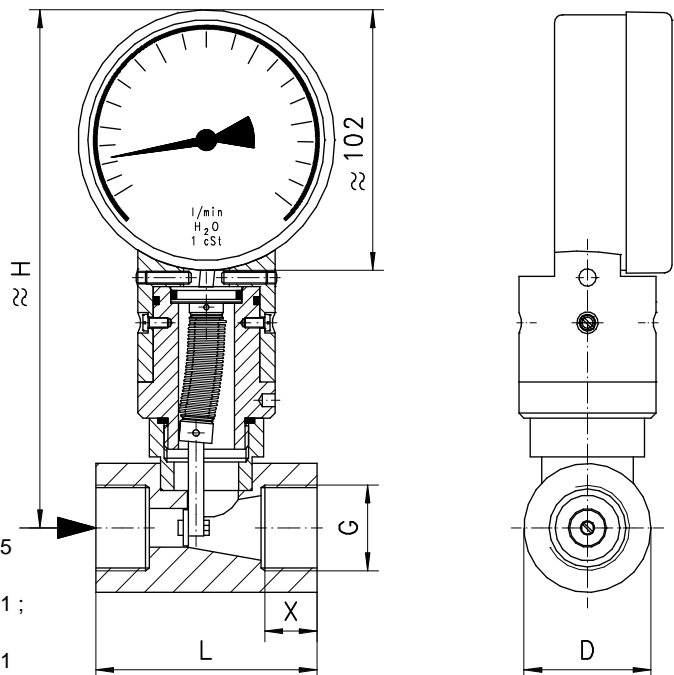

ELECTRICAL DATA

● **BASIC Standard**
No electrical components.

○ **BASIC Programme option**
integrated micro switch
with front switch units
see next page.

MOUNTING POSITION

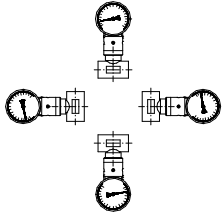

Installation position may influence metering range.

METERING SUBSTANCES

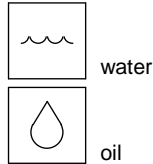

NOMENCLATURE

For combinations see table "technical data".

UZ-	015	G	M	035		basic type
UZ-					●	Flowmeter
UZM-					○	Flowmeter with integrated micro switch
	015				●	DN 15 - G1/2
	020				●	DN 20 - G3/4
	025				●	DN 25 - G1
	032				●	DN 32 - G1 1/4
	040				●	DN 40 - G1 1/2
	050				●	DN 50 - G2
		G			●	socket flange
			M		●	brass design
			K		●	stainless steel design
				035	○	35 l/min of full scale
				045	○	45 l/min of full scale
				050	●	50 l/min of full scale
				060	●	60 l/min of full scale
				070	○	70 l/min of full scale
				100	●	100 l/min of full scale
				200	●	200 l/min of full scale
				300	●	300 l/min of full scale
				500	●	500 l/min of full scale
Programme option					○	front switch unit with 10-kOhm-potentiometer
BASIC						
Special option					□	metering range for oil or gas
VARIO						front switch unit 2pol, n.o. or n.c. flange design

IMPORTANT FOR YOUR ORDER

- Please indicate flow direction, metering substance and metering range with your order
With pressure >1 bars abs please require metering range.
- With viscous liquids please indicate viscosity, temperature and metering substanc, e.g. ISO VG 68 (metering range on request)

All technical changes reserved

●BASIC Standard ○BASIC Programme option □VARIO Special option ⊕ PLUS Accessories ✗ not recommendable

OPTION

○ **UZM-** integrated micro switch

wiring 0.342 change over
250 V AC 5 A
plug DIN 43650-A
protection class IP 65

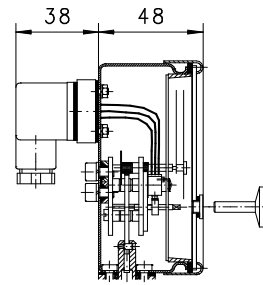
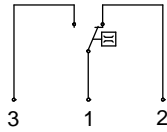

○ **UZP-** front switch unit with 10-kOhm- potentiometer

wiring 0.269
50 V DC 100 mA 1.5 W
resistance max. 10 kΩ
additional tolerance ±3 %
resistance tolerance ±1 %
linearity ±0.3 %
plug Hirschmann G4
protection class IP 60

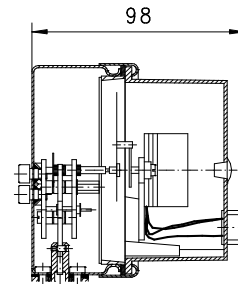
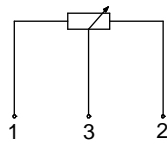

□ **UZM2-** switch unit with 2pole n.o.

wiring 0.268
250 V AC 0.6 A 50 VA
plug Hirschmann G4
protection class IP 60

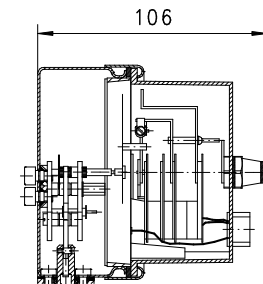
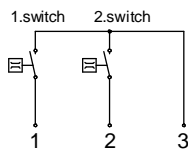

□ **UZM3-** switch unit with 2pole n.c.

wiring 0.285
250 V AC 0.6 A 50 VA
plug Hirschmann G4
protection class IP 60

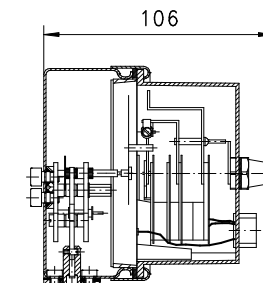
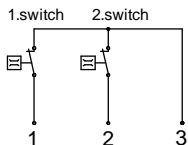

All technical changes reserved

●BASIC Standard ○BASIC Programme option □VARIO Special option ⊕ PLUS Accessories ✗ not recommendable